



TS/CV/DC CFD Team



Heat losses in Air for MBB Magnet in SPS ring

Antonio Romanazzi



Physical Problem (MBB magnet: 2D and 3D study)



- A liquid cooling system is designed to evacuate the heat generated by Joule effect (42.3 kW) in the magnet
- Losses through the environment are inevitable.
- The aim of this study is to give an estimation of heat dissipated in the environment and in the cooling system to check the design of ventilation system in the tunnel.

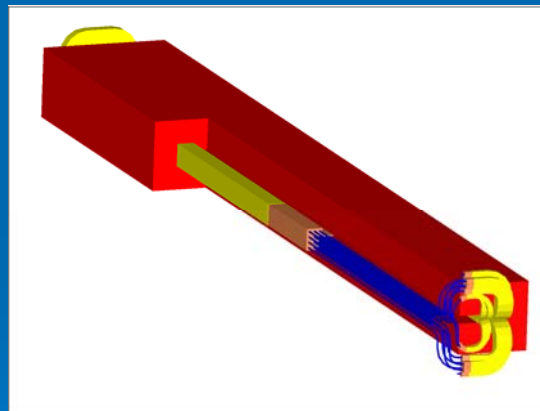

- Study divided into two parts: 2D preliminary study and 3D.

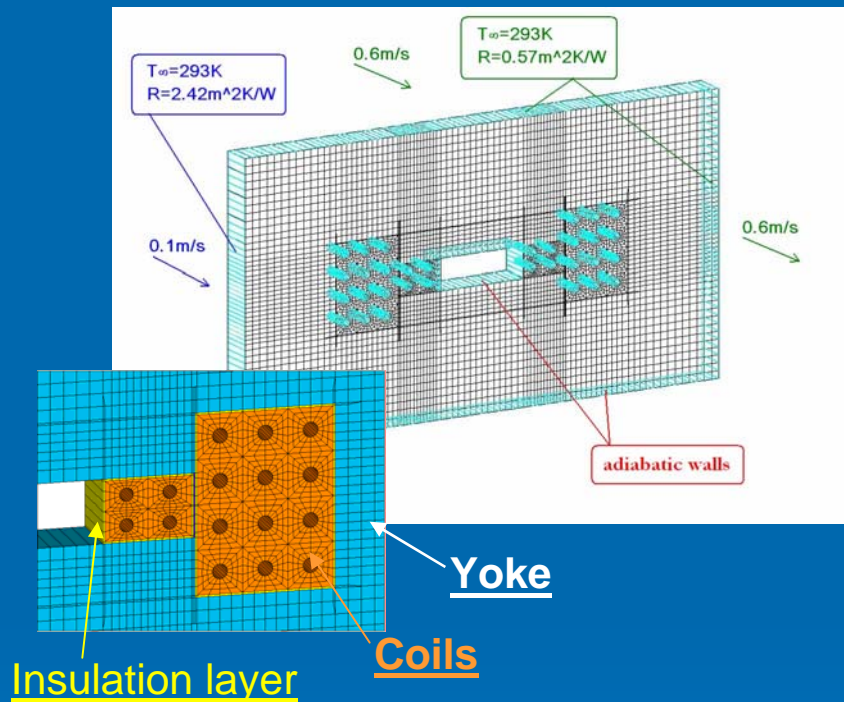

Temperatures for water are calculated assuming the behavior of fluid in the pipes linear (from 27° to 42°C).

The 2D model built represents a slice of the magnet in the middle cross section.

Cooling water and environmental air are not modeled but represented by boundary condition.

Convection coefficient for air was calculated from velocity and temperature of the fluid.

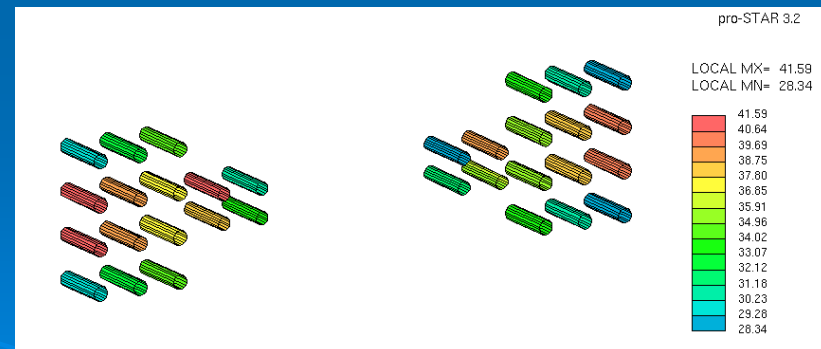



Results (2D MBB magnet)



heat dissipated
in water **322 W**

heat loss in air **1.5 W**

losses in air are the **0.5%**
of total heat generated

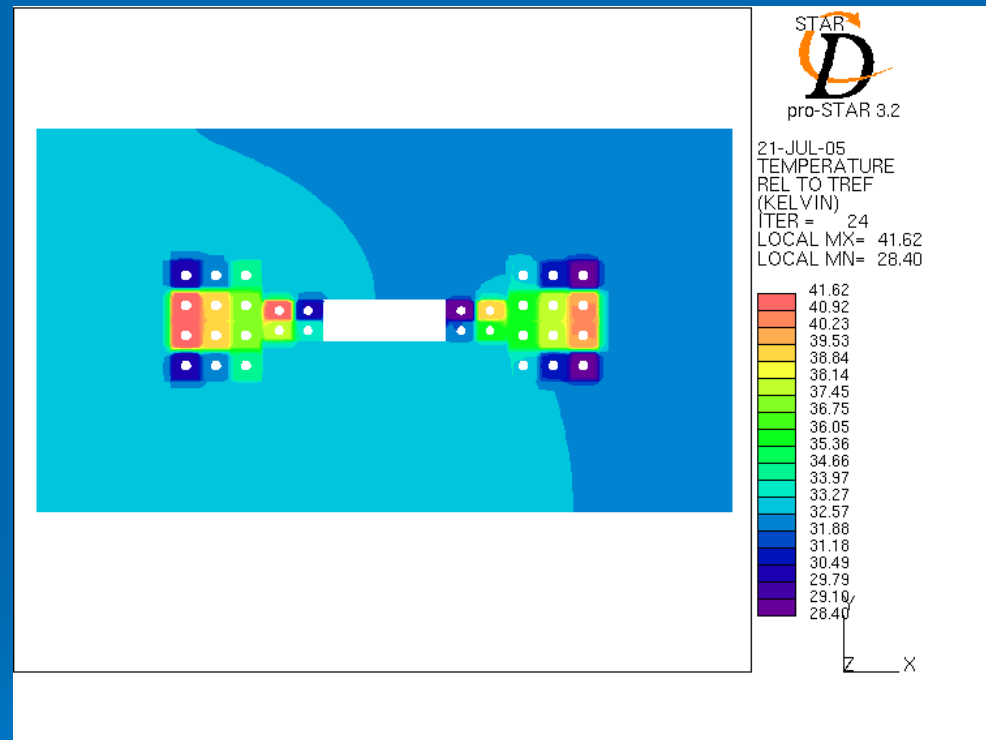

Antonio Romanazzi



3D Model (MBB magnet)



The water in the cooling system is modeled to calculate the heat exchange between different loop of cooling system pipes. Boundary conditions for water are only the mass flow.

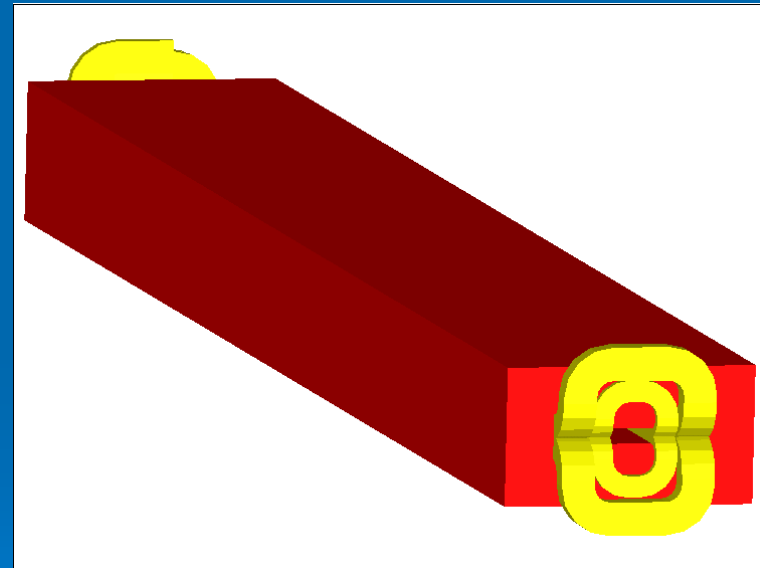
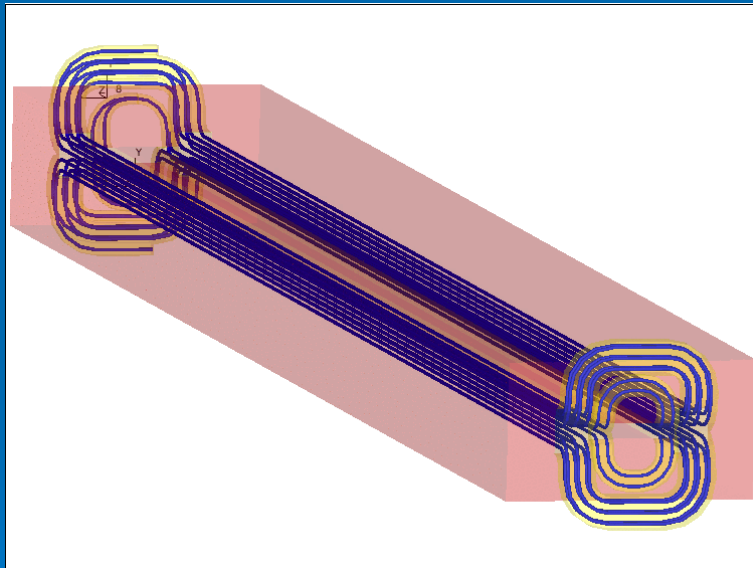

The air is still not modeled, were used the same approximations as for the 2D model.

Antonio Romanazzi



Results (3D MBB magnet)



Heat dissipated in water
42.03 kW
Heat loss in air
0.27 kW

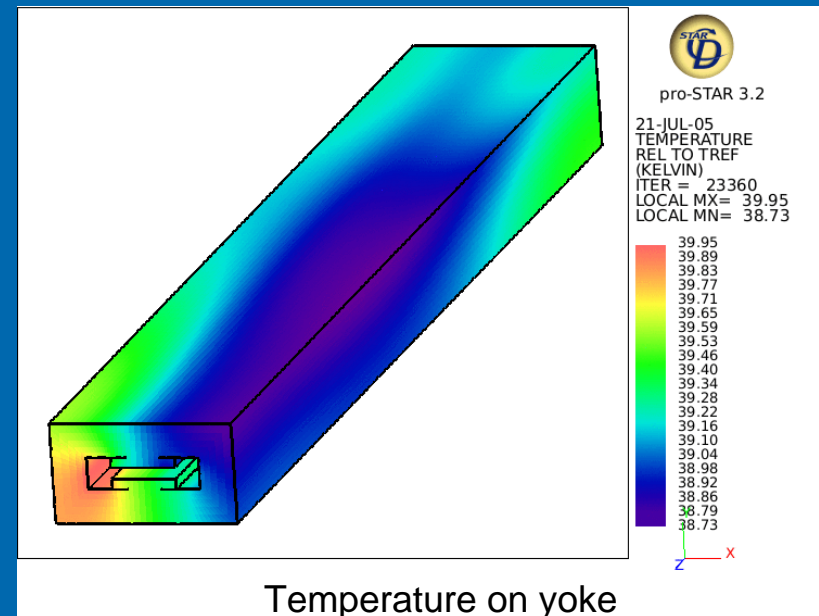
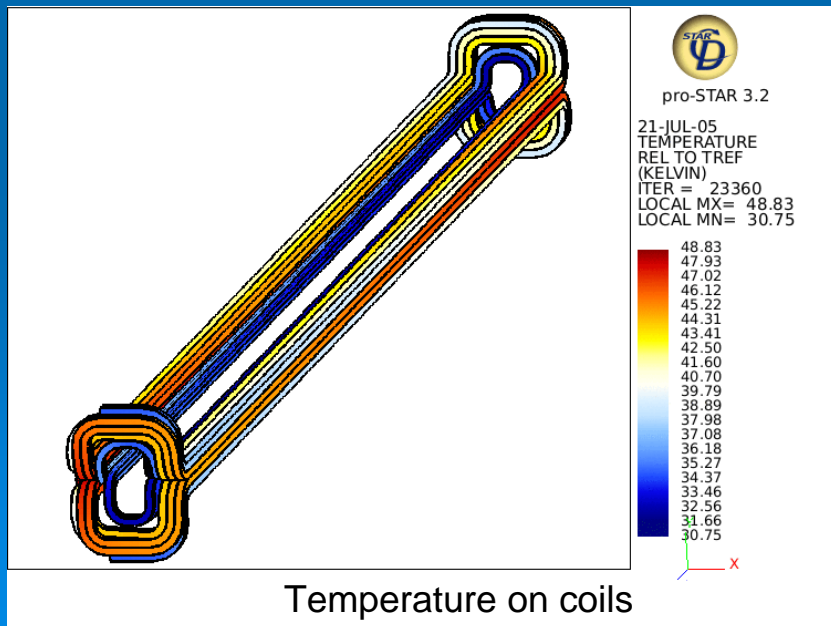

Losses in air are the **0.65%**
of total heat generated.

Antonio Romanazzi

Temperature in cooling water: higher dissipation in 3D model is due to real and non linear behavior of temperature into the conductors that differs between the three circuits.

